

Article number: 201356120

Description: E+G Klee vertical clamp
GN 820.1-355-P solid clamping arm

Measures

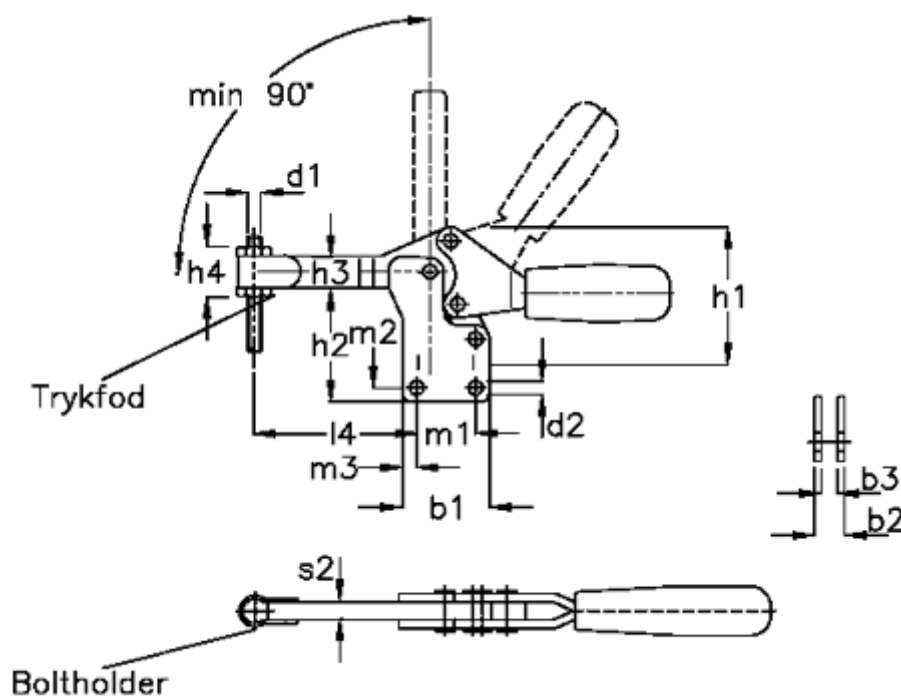

b1 = 60	Holding force N = 3200	Size = 300
b2 = 14	l1 = 270	
b3 = 7	l2 = 160	
d1 = M10	m1 = 41.0	
d2 = 8.5	m2 = 7.5	
h1 = 102.0	m3 = 9.5	
h2 = 69.0	r = 108.5	
h3 = 22	s = 7	